

Pressure switch for air DL

Technical Information · GB

4 Edition 05.13



- Precision differential pressure switch
- Monitoring of air, flue gas and other non-aggressive gases
- DL..EH: up to +110°C ambient temperature
- High switching point stability
- Switching point selection via hand wheel or adjusting screw
- Screw terminals or AMP plugs for electrical connections
- Flexible mounting options
- All connections accessible from one side
- EC type-tested and certified (DIN EN 1854)
- DL..ET, DL..KT: FM approved and UR recognized
- DL..AT, DL..KT: FM approved and UL listed
- Certified pursuant to GOST-R
- RoHS 2002/95/EC and follow-up directive 2011/65/EC



krom
schroder

Contents

Pressure switch for air DL	1	3.5 Connection diagram	14
Contents	2	3.5.1 Increasing pressure control	14
1 Application	4	3.5.2 Decreasing pressure control	14
1.1 Examples of application	4	3.5.3 DL 1,5A	14
1.2 Mounting examples	7	3.5.4 DL	14
1.2.1 Simple mounting	7	3.6 Animation	15
1.2.2 Mounting without the need for tools or screws	7	4 Selection	16
1.2.3 Pressure-resistant mounting on mounting plate	7	4.1 DL 3,3 – 40K selection table	17
1.2.4 Rugged, locked mounting	8	4.1.1 Type code	17
1.2.5 Mounting directly on the fan motor	8	4.1.2 Electrical connection	17
1.2.6 Protection against pressure surges	8	4.2 DL 2 – 35E selection table	18
1.2.7 Clearer handling in complex installations	9	4.2.1 Type code	18
1.2.8 Tube set with diverse possible applications	9	4.2.2 Electrical connection	18
1.2.9 Easier diagnosis and maintenance	10	4.2.3 Switching differential/switching point depends on installation position	18
2 Certification	11	4.3 DL 1,5 – 150A, DL 3 – 150K selection table	19
2.1 EC type-tested and certified	11	4.3.1 Type code	19
2.2 FM approval	11	4.3.2 Electrical connection	19
2.3 UR approval	11	4.3.3 Test key	19
2.4 UL approval	11	4.4 DL 1 – 50E selection table	20
2.5 AGA approval	11	4.4.1 Type code	20
2.6 Approval for Russia	11	4.4.2 Electrical connection	20
2.7 Overview	12	4.4.3 Test tapping point	20
3 Function	13	5 Project planning information	21
3.1 Positive pressure measurement	13	5.1 Installation	21
3.1.1 DL 1,5 A: hand wheel setting in the negative range	13	5.1.1 Installation position	21
3.2 Negative pressure measurement	13		
3.2.1 DL 1,5 A: hand wheel setting in the negative range	13		
3.3 Differential pressure measurement	13		
3.3.1 DL 1,5 A: hand wheel setting in the negative range	13		
3.4 Overview: measuring the pressure in the positive and negative ranges	13		

6 Accessories	22
6.1 Securing clip S	22
6.2 Securing clip D	22
6.3 L-angle bracket	22
6.4 Z-angle bracket	23
6.5 U-angle bracket	23
6.6 Tube set	23
6.7 Pilot lamp set, red or blue	24
6.8 LED set, red/green	24
6.9 Standard socket set	24
6.10 Motor flange adapter	24
6.11 Damping nozzle	24
6.12 Restrictor orifice	24
6.13 Colour coordination set	25
6.14 External adjustment	25
6.15 Pressure equalization element	25
6.16 Grommet	25
7 Technical data	26
7.1 DL..K	27
7.1.1 Dimensions	27
7.1.2 Adjusting range, switching differential	27
7.2 DL..A, DL..K	28
7.2.1 Dimensions	28
7.2.2 Adjusting range, switching differential	29
7.3 DL 1E – DL 50E	30
7.3.1 Dimensions	30
7.3.2 Adjusting range, switching differential	30
7.4 DL 2E – DL 35E	31
7.4.1 Dimensions	31
7.4.2 Adjusting range, switching differential	31
8 Maintenance cycles	32
Feedback	33
Contact	33

1 Application

Pressure switches for air DL can be used as positive pressure switches, vacuum sensors or differential pressure switches for air, flue gas and other non-aggressive gases. They are not suitable for fuel gases. They monitor extremely low pressure differentials.

They trigger switch-on, switch-off or switch-over operations if a set switching point is reached. This switching point can be adjusted using a hand wheel or, if required, it can be fixed using an adjusting screw.

The diaphragm pressure switch with micro switch features particularly high contact reliability as low gas release components are used.



Filter monitoring in kitchens

1.1 Examples of application



DL..K is used in air-conditioning systems and kitchens due to its low adjusting range (from 20 Pa).

The pneumatic and electrical connections on DL 3,3-40K are accessible from the same side in order to ensure space-saving and easy-to-fit installation.

The switching point can be infinitely adjusted using the hand wheel.

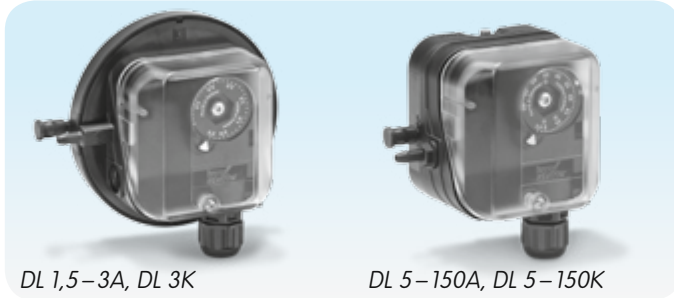

DL 1,5-3A, DL 3K

DL 5-150A, DL 5-150K

DL..A, DL..K are used for controlling butterfly valves for air and fire dampers in firing systems, and for fan monitoring.

DL 1,5 A (-0.5 to +1.5 mbar) is used in laboratories and special applications in particular.

On DL..A, the positive pressure can be connected via a threaded connection (Rp 1/4) in the lower housing section.

DL..A-3Z with tube connection for negative pressure also has a threaded connection Rp 1/8 for negative pressure. To use the threaded connection, the tube connection must be unscrewed (minus).

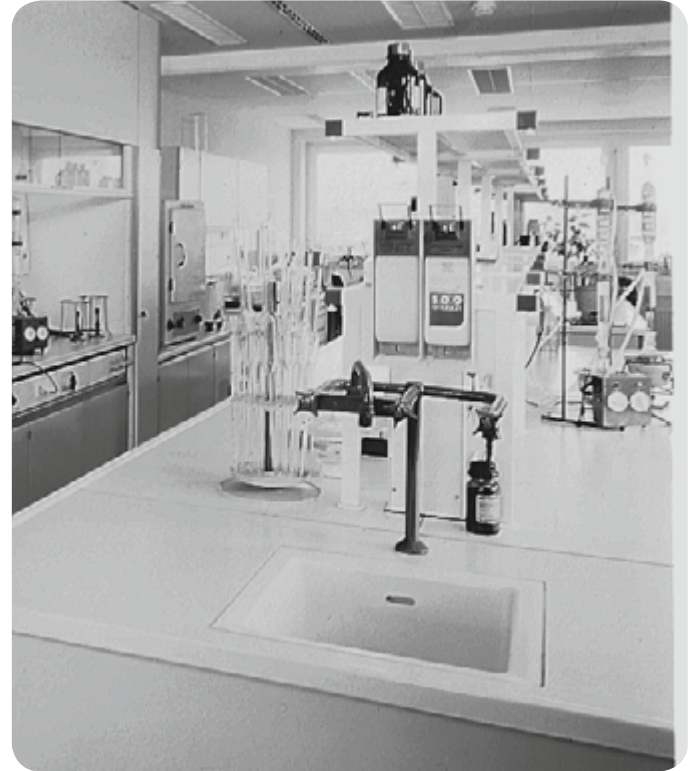

Fan monitoring in laboratories

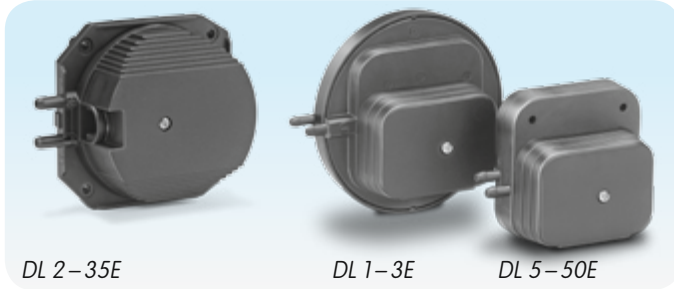

Thanks to its slim design and low adjusting range (20 to 5000 Pa/0.08 to 20 "WC), the fields of application of DL..E include fan monitoring on calorific value boiler units or on atmospheric wall-mounted units with flue gas fan.

On request, the air pressure switch DL..E can be supplied with only one NO contact, e.g. for a non-interchangeable connection to boiler control systems.



Heating boilers connected in cascade

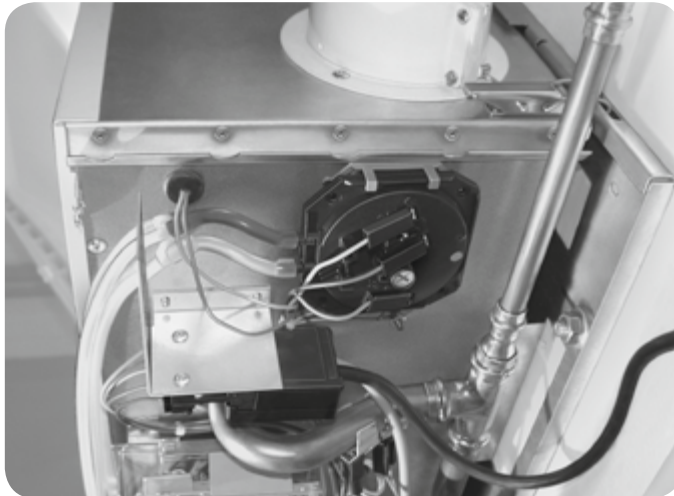

Pressure switch DL mounted on heating boiler using a D clip

1.2 Mounting examples

1.2.1 Simple mounting

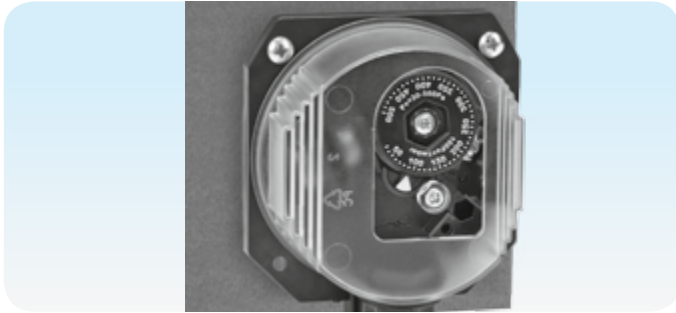

Simple front mounting. Mounting using two screws on the same side is usually sufficient and prevents the pressure switch being subjected to mechanical stress, see page 21 (Project planning information).

1.2.2 Mounting without the need for tools or screws

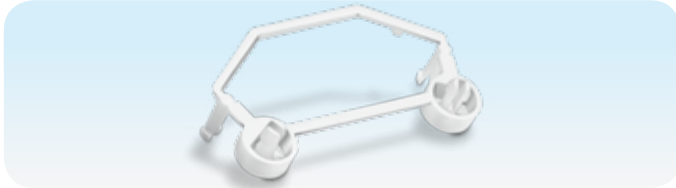

The securing clip S allows the pressure switch to be easily installed and removed. Only two holes in the mounting plate

or air duct are required for secure mounting. Securing clip S, see page 22 (Accessories).

1.2.3 Pressure-resistant mounting on mounting plate

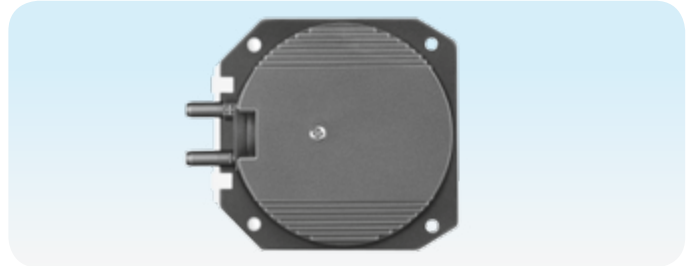
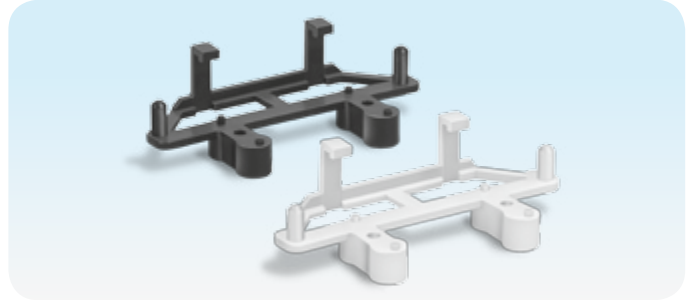

Attach the D clip to the mounting plate with the two screws supplied. Simply push the pressure switch onto the clip. The pressure switch can now be detached again at any time without the need for tools.

To reduce the amount of assembly work required, the pressure switch may, on request, be supplied with the clip already fitted. D clip, see page 22 (Accessories).

1.2.4 Rugged, locked mounting

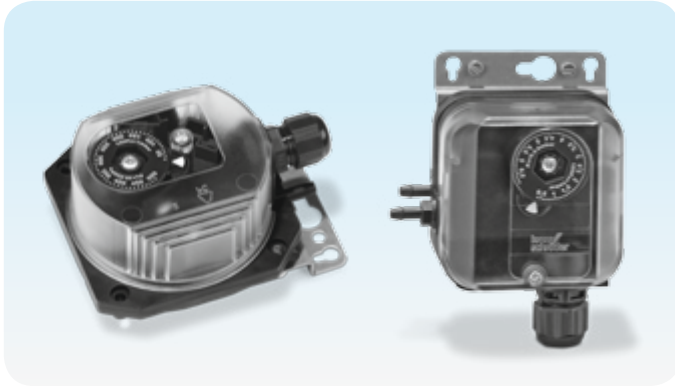
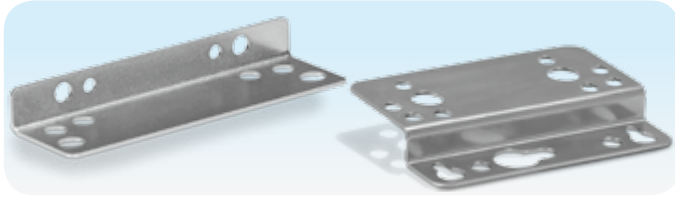

The L-shaped or Z-shaped angle bracket offers diverse mounting options, even with only one screw, and fast installation and removal. The angle bracket increases the distance between the pressure switch and warm boiler walls. Fastening set, see page 22 (Accessories).

1.2.5 Mounting directly on the fan motor

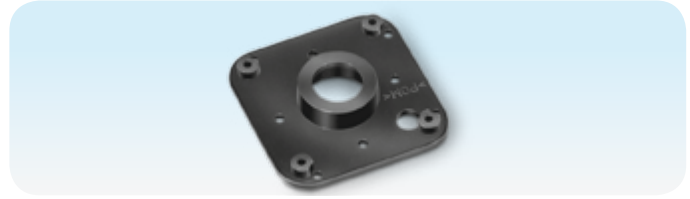

The pressure switch can be installed in a space-saving manner using the motor flange adapter. It is not necessary to drill holes for mounting. Motor flange adapter, see page 22 (Accessories).

1.2.6 Protection against pressure surges



The damping nozzle attenuates pressure fluctuations and pressure surges. A brief pressure surge occurs in the air supply line when igniting a burner, for example. Damping nozzle, see page 22 (Accessories).

1.2.7 Clearer handling in complex installations

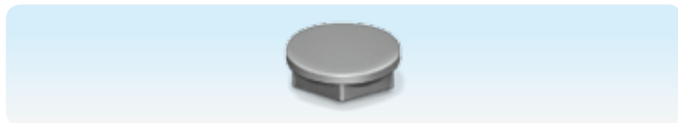

In order to facilitate reading for pressure switches with the same switching point setting, for example, a scale mark can be used. The scale mark can simply be clipped on and is available in different colours as a colour coordination set, see page 22 (Accessories).

1.2.8 Tube set with diverse possible applications



Duct connection flanges and angle connectors connect the pressure switch and pressure test point.

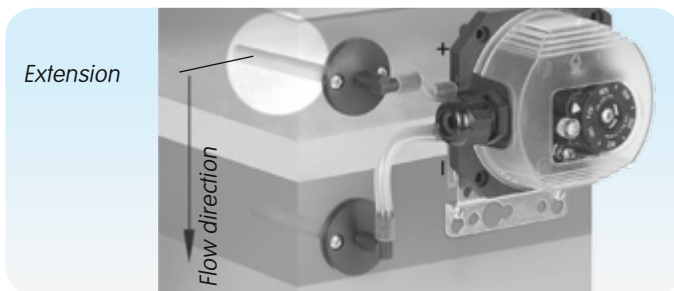
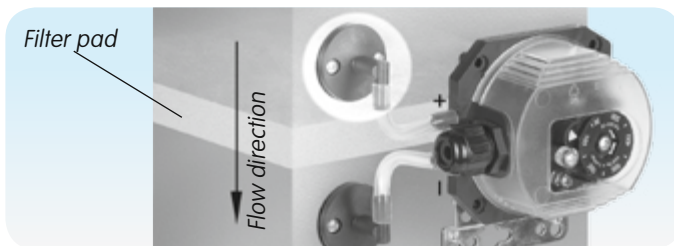

Using the extension, the pressure switch can be used on insulated and lagged ducts.

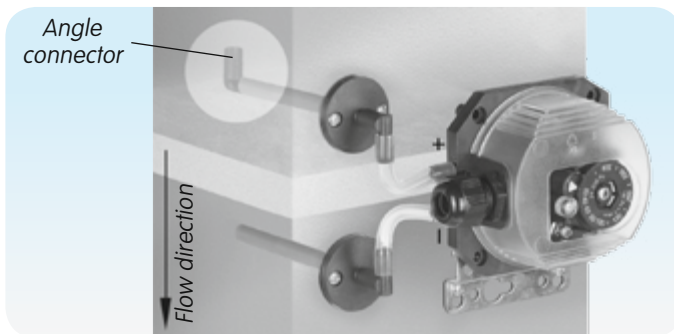

The angle connector reinforces the Δp signal if it is too low for the pressure switch adjusting range.

Tube set, see page 22 (Accessories).

1.2.9 Easier diagnosis and maintenance

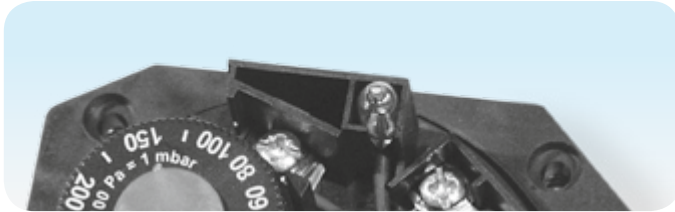
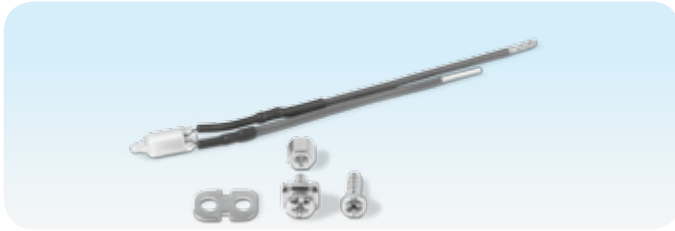

Either a red or a blue pilot lamp, or a red-green LED (24 V/230 V) indicates the switching status of the pressure switch, see page 22 (Accessories).

2 Certification

2.1 EC type-tested and certified



pursuant to

- Gas Appliances Directive (2009/142/EC) in conjunction with EN 1854,
- Low Voltage Directive (2006/95/EC) in conjunction with the relevant standards.
- Declaration of conformity (D, GB) – see www.docuthek.com → Elster Kromschroder → Kromschroder, LBE → Products → 04 Pressure switches → Pressure switches for air → Kind of document: Certificate → DL.. → DL.. (K OS Konformitätserklärung)

2.2 FM approval



Factory Mutual Research Class: 3510 Flow and pressure safety switches. Designed for applications pursuant to NFPA 85 and NFPA 86. www.approvalguide.com

2.3 UR approval



UL 353 Limit control.

DL.: AMP plug connection, see page 12 (Overview).

Underwriters Laboratories – www.ul.com → Tools (at the bottom of the page) → Online Certifications Directory

2.4 UL approval



UL 353 Limit control.

DL.: electrical connection via screw terminals, see page 12 (Overview).

Underwriters Laboratories – www.ul.com → Tools (at the bottom of the page) → Online Certifications Directory

2.5 AGA approval



Australian Gas Association, Approval No.: 5484 – http://www.aga.asn.au/product_directory

2.6 Approval for Russia









Certified by Gosstandart pursuant to GOST-R.

Approved by Rostekhnadzor (RTN).

Scan of the approval for Russia (RUS) – see www.docuthek.com → Elster Kromschroder → Kromschroder, LBE → Products → 04 Pressure switches → Pressure switches for air → Kind of document: Certificate → DL.. → DL B12185 (nationales Zertifikat Russland) (RUS)

2.7 Overview

	Type
 2006/95/EC	DL 1–3E, DL 5–50E, DL 2–35E, DL 3,3–40K, DL 3K, DL 5–150K, DL 1,5–3A, DL 5–150A
 2009/142/EC EN 1854	DL 1–3E, DL 5–50E, DL 2–35E, DL 3,3–40K, DL 3K, DL 5–150K, DL 1,5–3A, DL 5–150A
	DL 1–3E, DL 5–50E, DL 3A, DL 5–150A, DL 3K, DL 5–150K
	DL 1–3E, DL 5–50E, DL 2–35E, DL 3,3–40K, DL 3K, DL 5–150K, DL 1,5–3A, DL 5–150A
	DL 1–3ET, DL 5–50ET, DL 2–35ET, DL 3,5–40KT-3, DL 3AT, DL 3KT, DL 5–50AT, DL 5–50KT
	DL 3AT, DL 5–50AT, DL 3,5–40KT-3 (except DL 3,3KT-3/DL 5,1KT-3), DL 3KT, DL 5–50KT
	DL 2–35ET, DL 3,5–40KT-1 (except DL 3,3KT-1/DL 5,1KT-1), DL 1–3ET, DL 5–50ET

* DL..-3 with screw terminals: UL listed.

** DL..-1 with AMP plugs: UR recognized.

3 Function

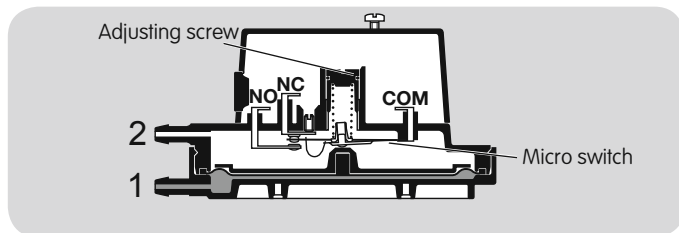
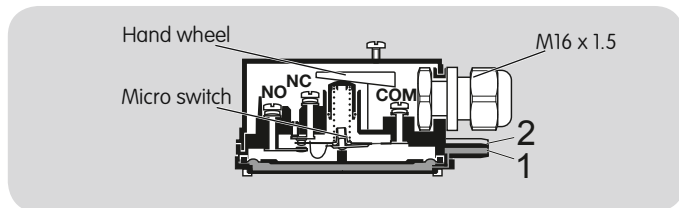

The air pressure switch DL switches in the event of increasing or decreasing pressure. Once the set switching point is reached, a micro switch is activated in the DL.

The switching pressure is adjusted against a spring force using a hand wheel or an adjusting screw.

3.1 Positive pressure measurement

Positive pressure measurement is designed, for example, for checking the fan function or measuring the min./max. pressure.

The positive pressure is measured in the lower diaphragm chamber, port 1. The upper diaphragm chamber is ventilated via port 2.

3.1.1 DL 1,5 A: hand wheel setting in the negative range

The positive pressure is measured in the upper diaphragm chamber, port 2. The lower diaphragm chamber is ventilated via port 1.

3.2 Negative pressure measurement

Negative pressure measurement is designed, for example, for checking air locks or the fan function.

The negative pressure is measured in the upper diaphragm chamber, port 2. The lower diaphragm chamber is ventilated via port 1.

3.2.1 DL 1,5 A: hand wheel setting in the negative range

The negative pressure is measured in the lower diaphragm chamber, port 1. The upper diaphragm chamber is ventilated via port 2.

3.3 Differential pressure measurement

Differential pressure measurement is designed for safeguarding an air flow rate or for monitoring filters and fans, for instance.

The higher absolute pressure is connected to port 1 and the lower absolute pressure to port 2. The remaining ports must be tightly plugged.

3.3.1 DL 1,5 A: hand wheel setting in the negative range

The higher absolute pressure is connected to port 2 and the lower absolute pressure to port 1. The remaining ports must be tightly plugged.

3.4 Overview: measuring the pressure in the positive and negative ranges

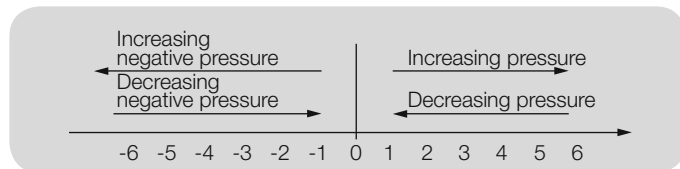

3.5 Connection diagram

3.5.1 Increasing pressure control

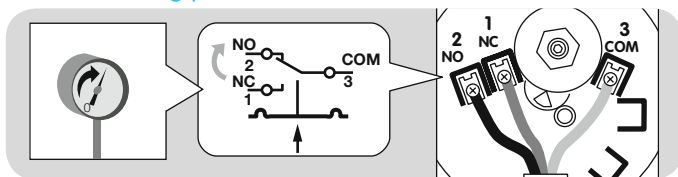

When the set switching point is reached, the contact closes from COM 3 to NO 2. Contact COM 3 to NC 1 is opened. With the NO contact, the NC contact is omitted.

3.5.2 Decreasing pressure control

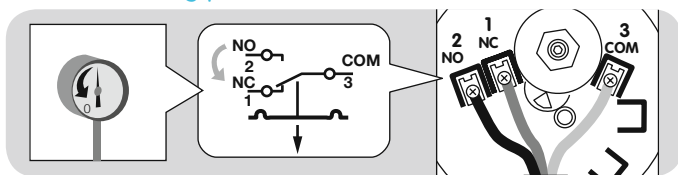

When the set switching point is reached, the contact closes from COM 3 to NC 1. Contact COM 3 to NO 2 is opened. With the NO contact, the NC contact is omitted.

3.5.3 DL 1,5A

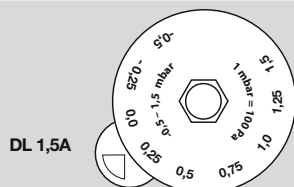

The connection of DL 1,5A depends on the positive or negative adjusting range.

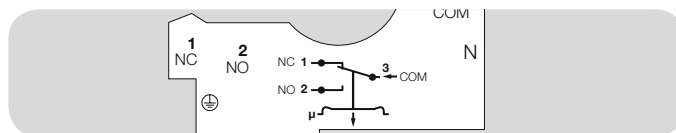

In the negative adjusting range, the template which can be found in the unit displays the connection diagram.

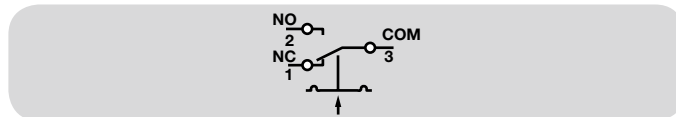

In the positive adjusting range, remove the template and wire the unit as shown in the engraved connection diagram.

3.5.4 DL

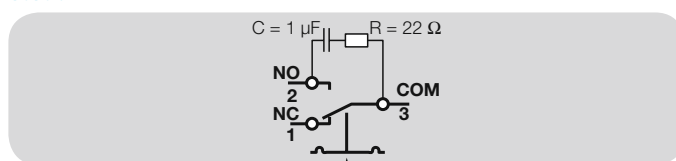

When using silicone tubes, only use silicone tubes which have been sufficiently cured. Vapours containing silicone can adversely affect the functioning of electrical contacts. In the case of low switching capacities, such as 24 V, 8 mA, for example, we recommend using an RC module (22 Ω, 1 μF) in air containing silicone or oil.

In the case of high humidity or aggressive gas components (H₂S), we recommend using a pressure switch with gold contact due to its higher resistance to corrosion. Closed-circuit current monitoring is recommended under difficult operating conditions.

3.6 Animation

DL..A

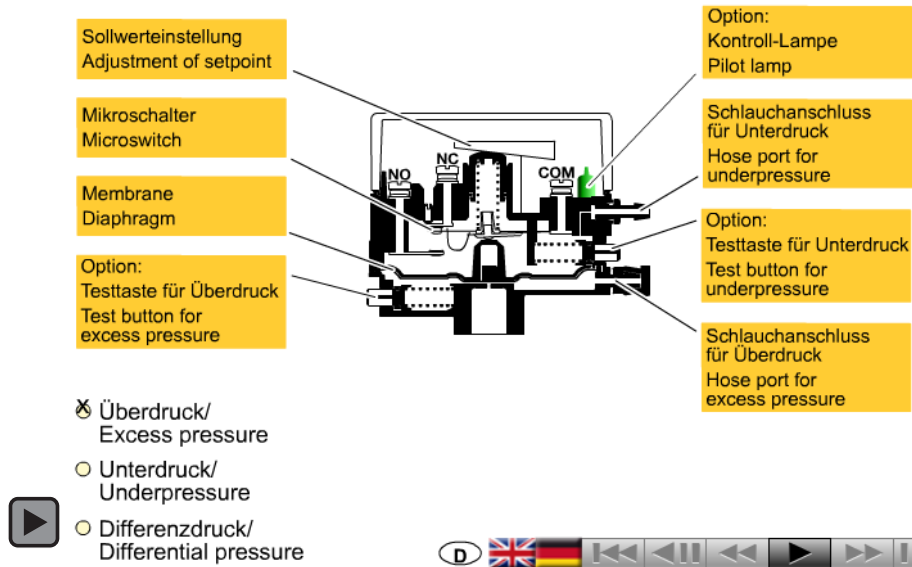
krom
schroder

The interactive animation shows the function of the air pressure switch DL..A.

Click on the picture. The animation can be controlled using the control bar at the bottom of the window (as on a DVD player).

To play the animation, you will need Adobe Reader 7 or a newer version. If you do not have Adobe Reader on your system, you can download it from the Internet.

Go to www.adobe.com, click on "Adobe Reader" in the "Download" section and follow the instructions.

If the animation does not start to play, you can download it from the document library (Docuthek) as an independent application.

4 Selection

Type	Frequent application		Version													Mounting			Accessories		Enclosure (IP)				
	Air-conditioning systems and kitchens	Condensing boilers Laboratories, industrial firing systems, butterfly valves for air and fire dampers	Adjusting range in Pascal	Adjusting range in mbar	Hand wheel	Adjusting screw	Screw terminals	AMP plugs	Tube connection	Threaded connection	Pilot lamp/Pilot LED	Standard socket set	Test key in lower chamber	Test key in upper chamber	Measuring instrument/pressure signal connection	Securing clip S	Securing clip D	L-angle bracket	Z-angle bracket	U-angle bracket	External adjustment	Tube set	Motor flange adapter	Standard	Maximum*
DL 3,3–40K	●		●		●		●	○	●		○				○	○	○	○	○		○	○	○	54	54
DL 2–35E		●	●			●	●	●							○	○	○	○	○		○	○	○	10/21	44
DL 1,5–3A			○	●	●		●	●	●		○	○						○	○	○	○	○	○	54	65
DL 5–150A			○	●	●		●	●	●		○	○	●	○				○	○	○	○	○	○	54	65
DL 3K	●		○	●	●		●	●		○	○							●	○	○	○	○	○	54	65
DL 5–150K	●		○	●	●		●	●		○	○							●	○	○	○	○	○	54	65
DL 1–3E		●	○	●		●		●	●									○	○		○	○	○	10/21	44
DL 5–50E		●	○	●		●		●	●					○				○	○		○	○	○	10/21	44

● = standard, ○ = available

*The enclosure depends on the version, installation position and whether a cable grommet is being used.

4.1 DL 3,3–40K selection table

Type	3,3 ¹⁾	3,5	4,5	5,1 ¹⁾	8	11	16	24	40	K	T	G	-1 ²⁾	-3 ³⁾	K2	N	T	T2	W	
DL	●	●	●	●	●	●	●	●	●	●	●	●	○	●	○	○	○	○	○	○

Order example

DL 8KG-3

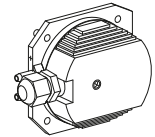

¹⁾ Not available as a T-product.

²⁾ DL..KT-1 with AMP plugs: UR recognized.

³⁾ DL..KT-3 with screw terminals: UL listed.

● = standard, ○ = available

4.1.1 Type code

Code	Description
DL	Pressure switch for air
	Adjusting range
3,3	20–330 Pa
3,5	30–350 Pa
4,5	30–500 Pa
5,1	100–510 Pa
8	50–800 Pa
11	100–1100 Pa
16	400–1600 Pa
24	200–2400 Pa
40	500–4000 Pa
K	Tube connection and hand wheel for adjustment
T	T-product
G	Gold contacts
-1	AMP plug connection
-3	Electrical connection via screw terminals
K2	Red/green pilot LED 24 V DC/AC
N	Blue pilot lamp 120 V AC
T	Blue pilot lamp 230 V AC
T2	Red/green pilot LED 230 V AC
W	Z-angle bracket

4.1.2 Electrical connection

DL..K-1 for wiring with AMP plugs

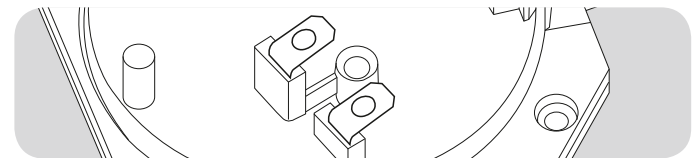

DL..K-3 for wiring via screw terminals

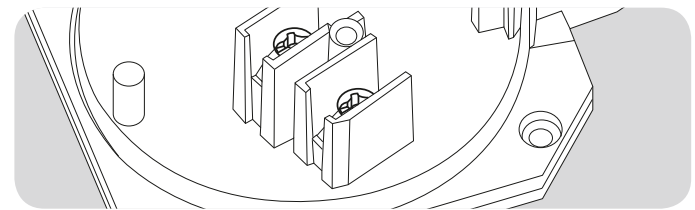

Switching point and switching differential, see page 27 (Adjusting range, switching differential).

4.2 DL 2–35E selection table

Type	2 ¹⁾	4	14	35	EH	E	T	G	-1	W
DL	●	●	●	●	○	●		●	●	○

¹⁾ Switching point 20–30 Pa when installed upside down.

● = standard, ○ = available

Order example

DL 4EHG-1

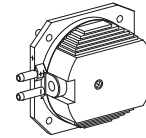

4.2.1 Type code

Code	Description
DL	Pressure switch for air
	Adjusting range
2 ¹⁾	20–200 Pa
4 ¹⁾	50–400 Pa
14	300–1400 Pa
35	1200–3500 Pa
EH	With flat plugs, tube connection, adjusting screw, -40 to +110°C
E	-15 to +85°C
T	T-product
G	Gold contacts
-1	AMP plug connection
W	Z-angle bracket

¹⁾ Adjusting range: DL..2EH: 45–200 Pa, DL..4EH: 70–200 Pa.

Switching point and switching differential, see page 31 (Adjusting range, switching differential).

4.2.2 Electrical connection

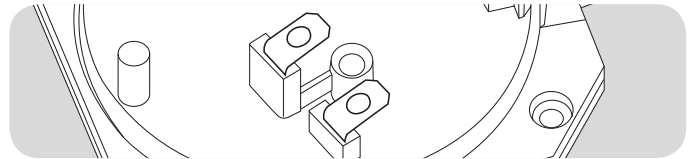

Wiring with AMP plugs

4.2.3 Switching differential/switching point depends on installation position

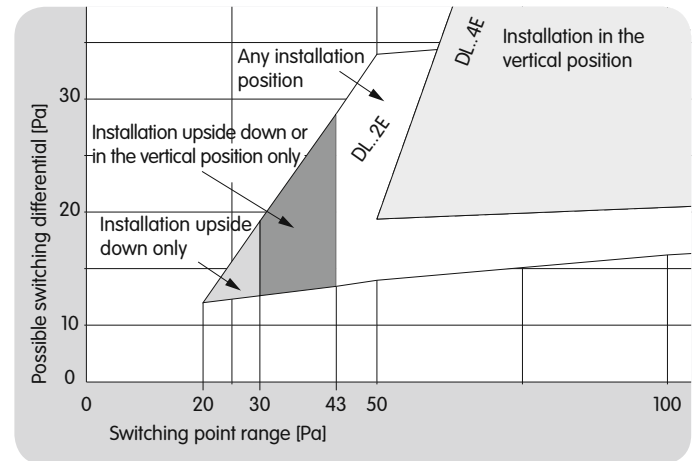

4.3 DL 1,5–150A, DL 3–150K selection table

Type	1,5 ¹⁾²⁾	3	5	10	30	50	150 ²⁾	K	A	T	G	-3 ³⁾	-4 ³⁾	-5 ³⁾	-6 ³⁾	-9 ³⁾	K2	T	T2	N	p ⁴⁾	1 ⁵⁾	2 ⁵⁾	A	W	
DL	●	●	●	●	●	●	●	●	●	●	●	●	○	○	○	○	○	○	○	○	○	○	○	○	○	○

¹⁾ Only available as DL..A.

²⁾ Not available as a T-product.

³⁾ DL..KT-3 with screw terminals: UL listed.

⁴⁾ Only for DL 5–150K.

⁵⁾ Only for DL 5–150A.

● = standard, ○ = available

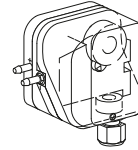

Order example

DL 150K-3T

4.3.1 Type code

Code	Description
DL	Pressure switch for air
1,5	Adjusting range -0.5–1.5 mbar
3 ¹⁾	0.2–3 mbar
5 ¹⁾	0.4–5 mbar
10	1–10 mbar
30	2.5–30 mbar
50	2.5–50 mbar
150	30–150 mbar
K	With tube connection and hand wheel
A	Additionally with Rp 1/4 connection
T	T-product
G	Gold contacts
-3	Electrical connection via screw terminals
-4	via screw terminals, IP 65
-5	with 4-pin plug, without socket
-6	with 4-pin plug, with socket
-9	with 4-pin plug, with socket, IP 65
K2	Red/green pilot LED 24 V DC/AC
T	Blue pilot lamp 230 V AC
T2	Red/green pilot LED 230 V AC
N	Blue pilot lamp 120 V AC
P	With test tapping point
1	With 1 test key (lower chamber +)
2	With 2 test keys (upper chamber -, lower chamber +)
A	External adjustment
W	Z-angle bracket

¹⁾ Adjusting range: DL..3AT: 0.3 – 3 mbar, DL 5AT and DL 5KT: 0.5 – 5 mbar

Switching point and switching differential, see page 29 (Adjusting range, switching differential).

4.3.2 Electrical connection

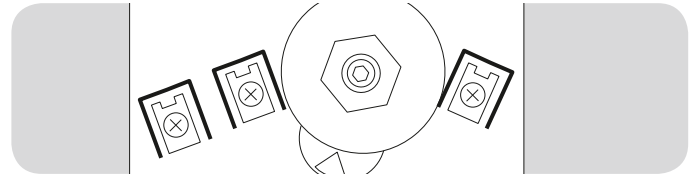

Wiring via screw terminals

4.3.3 Test key

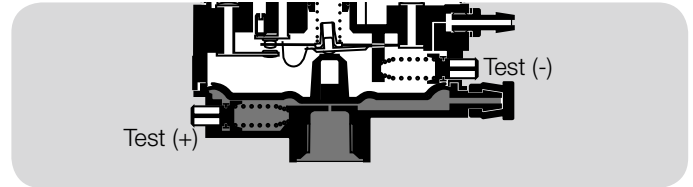

DL 5–150A..1: test key in lower chamber (+) or
DL 5–150A..2: test key in lower chamber (+) and upper chamber (-).

4.4 DL 1–50E selection table

Type	1	3	5	10	50	E	T	G	-1 ¹⁾	P	W
DL	●	●	●	●	●	●	●	●	●	●	○

¹⁾ DL..ET with AMP plugs: UR recognized.

● = standard, ○ = available

4.4.1 Type code

Code	Description
DL	Pressure switch for air
	Adjusting range
1	0.2–1 mbar
3	0.3–3 mbar
5 ¹⁾	0.4–5 mbar
10	1.0–10 mbar
50	2.5–50 mbar
E	With flat plugs, tube connection, adjusting screw
T	T-product
G	Gold contacts
-1	AMP plug connection
P	With test tapping point
W	Z-angle bracket

¹⁾ DL..5ET: adjusting range 0.5 – 5 mbar.

Switching point and switching differential, see page 30 (Adjusting range, switching differential).

Order example

DL 50EG-1

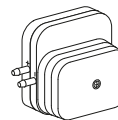

4.4.2 Electrical connection



DL..E-1 for wiring with AMP plugs

4.4.3 Test tapping point

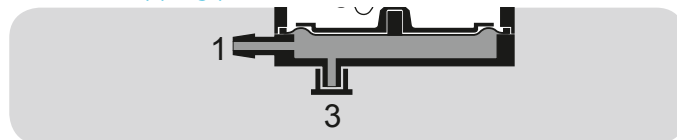

DL 5–50E-1P: a measuring instrument can be connected to port **3** or the boiler pressure can be queried. If port **3** is used for pressure measurement, the sealing cap must be transferred from port **3** to **1**.

5 Project planning information

5.1 Installation

Continuous operation at high temperatures (e.g. maximum ambient temperature) accelerates the ageing of elastomer materials and reduces the service life (please contact manufacturer). Ozone concentrations exceeding $200 \mu\text{g}/\text{m}^3$ or gases containing more than 0.1 %-by-vol. H_2S accelerate the ageing of elastomer materials and reduce the service life.

Protect the connections against dirt or moisture in the medium to be measured or the surrounding air. If necessary, install a filter.

When installing outdoors, place the DL in a roofed area and protect from direct sunlight (even IP 65 version). To avoid condensation, the cover with pressure equalization element can be used on some types, see page 25 (Pressure equalization element).

In case of highly fluctuating pressures, install a damping nozzle or restrictor orifice, see pages 24 (Damping nozzle) and 24 (Restrictor orifice).

In the case of uneven ground, secure the pressure switch to the mounting plate or air duct with only two screws on the same side in order to avoid subjecting the pressure switch to mechanical stress.

5.1.1 Installation position

Condensation must not be allowed to get into the housing (if possible, install pipework with an ascending gradient). Otherwise, there is a risk of icing of condensation at subzero temperatures, the switching point shifting or corrosion in the device which can lead to malfunctions.

Installation in the vertical or horizontal position, or upside down, preferably with vertical diaphragm.

If installed in a vertical position, the switching point p_S will correspond to the scale value SK. If installed in another position, the switching point p_S will change and no longer correspond to the set scale value SK. Switching point p_S must be checked.

	$p_S = SK$	SK + 13 Pa [+ 0.052 "WC]	SK - 13 Pa [- 0.052 "WC]
DL 3,3–40K			
DL 2–35E			
	$p_S = SK$	SK + 18 Pa [+ 0.071 "WC]	SK - 18 Pa [- 0.071 "WC]
DL 1E, DL 3E			
DL 5E, DL 10E, DL 50E			
	$p_S = SK$	SK + 0.18 mbar [+ 0.071 "WC]	SK - 0.18 mbar [- 0.071 "WC]
DL 1,5A		 e.g. SK = -0.5: $p_S = -0.5 + 0.18$ $p_S = -0.32 \text{ mbar}$	
DL 3K, DL 3A			
DL 5–150A, DL 5–150K			

6 Accessories

6.1 Securing clip S

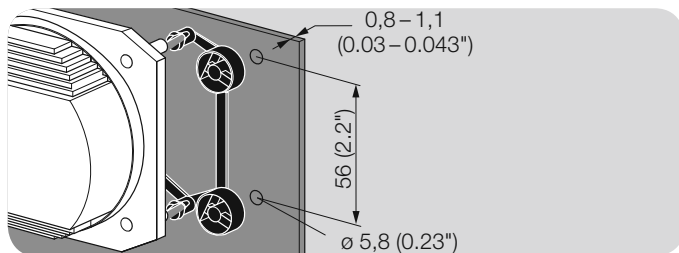

For DL 2–35E and DL 3,3–40K:

Only two holes in the mounting plate or air duct are required for secure mounting. Order No.: 34335764.

6.2 Securing clip D

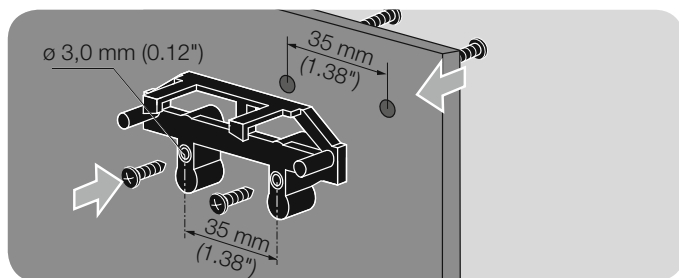

For pressure-resistant mounting, the D clip is fitted to the mounting plate from the front or from the back. Simply push the pressure switch onto the clip.

For DL 2–35E, DL 3,3–40K:

For attachment to the side of the pressure port, white clip,

Order No.: 74921513,

for attachment to the three other sides, blue clip,

Order No.: 74921512.

6.3 L-angle bracket

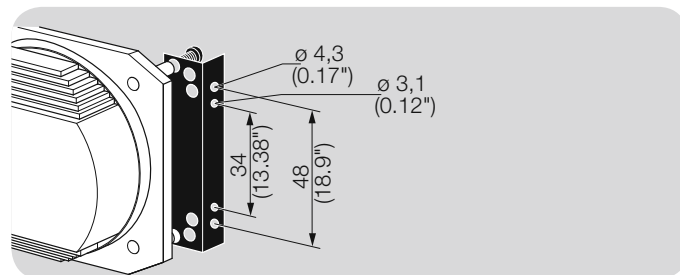

For DL 2–35E and DL 3,3–40K: shape A,
Order No.: 74919825.

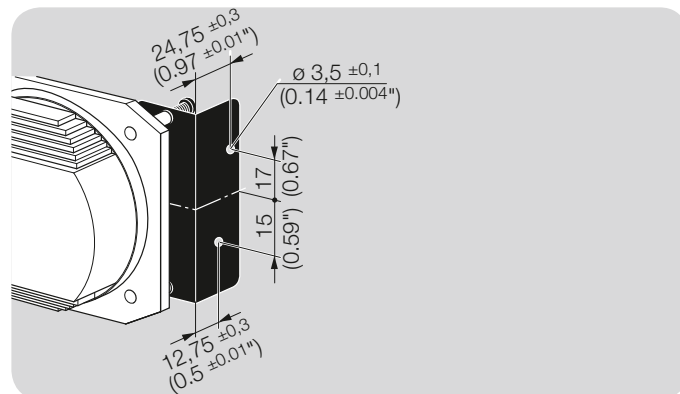

For DL 2–35E and DL 3,3–40K: shape B,
Order No.: 74921466.

6.4 Z-angle bracket

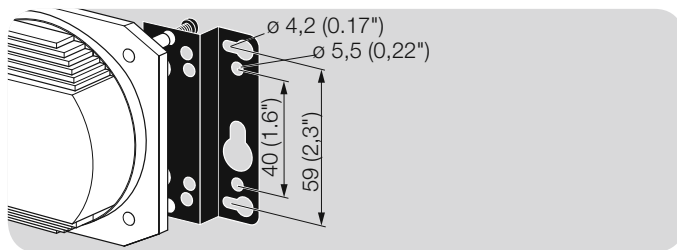

For DL 2–35E and DL 3,3–40K: Order No.: 74919824,
 DL 5–50E and DL 5–150K: Order No.: 74916158,
 DL 3–150A, DL 3K and DL 1–3E: Order No.: 74913661.

6.5 U-angle bracket

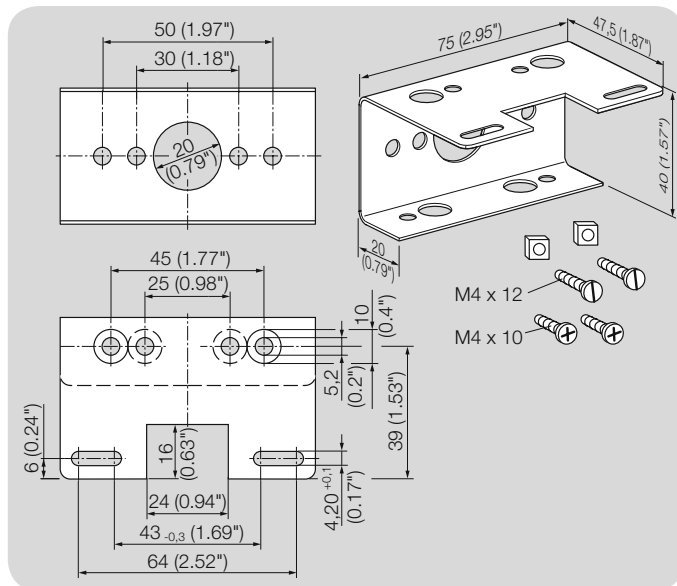

For DL 1,5–150A, DL 3–150K, DL 1–50E:
 Order No.: 74916185.

6.6 Tube set

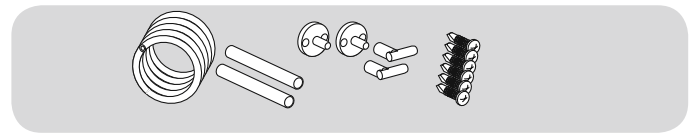

Tube set, including angle connectors and extension:
 Order No.: 74919272.

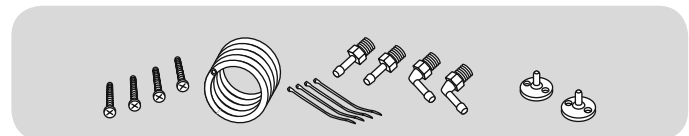

Tube set with 2 m PVC tube, 2 duct connection flanges with screws, R 1/4 and R 1/8 connecting nipples:
 Order No.: 74912952.

6.7 Pilot lamp set, red or blue

For DL..K and DL..A

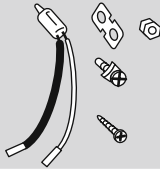

Pilot lamp, red:

110/120 V AC, I = 1.2 mA, Order No.: 74920430,

220/250 V AC, I = 0.6 mA, Order No.: 74920429.

Pilot lamp, blue:

110/120 V AC, I = 1.2 mA, Order No.: 74916121,

220/250 V AC, I = 0.6 mA, Order No.: 74916122.

6.8 LED set, red/green

For DL..K and DL..A

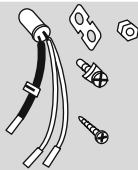

24 V DC, I = 16 mA; 24 V AC, I = 8 mA, Order No.: 74921089,

230 V AC, I = 0.6 mA, Order No.: 74923275.

6.9 Standard socket set

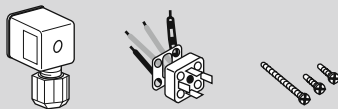

DL..A, DL..K: Order No.: 74916159.

6.10 Motor flange adapter

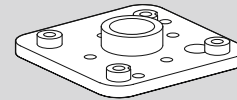

DL 5–50E, Order No.: 74916149,

DL 1–3E, DL 3–150E, DL 3–5K, Order No.: 74916157,

DL 5–150K, Order No.: 74916156,

DL 2/4/14/35E, DL 3,5/4,5/8/16/24/40K, Order No.: 74920415.

6.11 Damping nozzle



In the case of high pressure fluctuations, we recommend using a damping nozzle for tube connections: $\varnothing = 0.8 \text{ mm}$ (0.03"), Order No.: 35451346.

6.12 Restrictor orifice

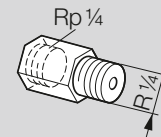

In the case of high pressure fluctuations, we recommend using a restrictor orifice (contains non-ferrous metals) for Rp $\frac{1}{4}$ threaded connections:

Hole diameter 0.2 mm, Order No.: 75456321,

hole diameter 0.3 mm, Order No.: 75441317.

6.13 Colour coordination set

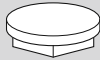

The scale mark is available in each case as a 5-piece set.
 Colour coordination set, blue, Order No.: 74921726,
 Colour coordination set, yellow, Order No.: 74921727.

6.14 External adjustment



In order to set the switching pressure from the outside, the cover for external adjustment (6 mm Allen key) for DL 1,5–150A, DL 3–150K can be retrofitted.

Order No.: 74916155.

6.15 Pressure equalization element

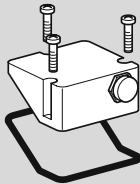

To avoid the formation of condensation, the cover with pressure equalization element can be used. The diaphragm in the screw connector is designed to ventilate the cover, without allowing water to enter.

Order No.: 74923391.

6.16 Grommet

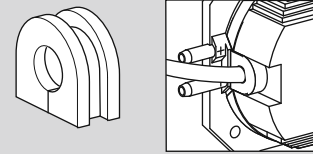

Grommet for enclosure IP 44.

DL 2/4/14/35E: Order No.: 34919801.

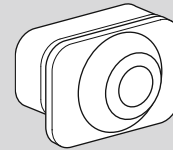

Grommet for enclosure IP 42.

DL 1/3/5/10/50E: Order No.: 34328197.

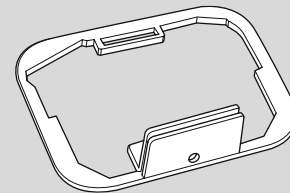

Grommet for enclosure IP 44.

DL 1/3/5/10/50E: Order No.: 34330703.

7 Technical data

Gas types: air or flue gas, no flammable gases, no aggressive gases.

Micro switch to EN 61058-1,
switching capacity:

DL..: 24 V (min. 0.05 A) to 250 V AC
(max. 5 A, with $\cos \varphi = 1$ A),

DL..G: 5 V (min. 0.01 A) to 250 V AC
(max. 5 A, with $\cos \varphi = 1$ A),
5 V (min. 0.01 A)
to 48 V DC (max. 1 A),

DL..T: 30–240 V AC, 50/60 Hz,
5 A resistive or
0.5 A inductive ($\cos \varphi = 0.6$),

DL..TG: < 30 V AC/DC,
0.1 A resistive or
0.05 A inductive ($\cos \varphi = 0.6$).

If the DL..G (DL..TG) has switched a voltage > 24 V (> 30 V) and a current > 0.1 A at $\cos \varphi = 1$ or > 0.05 A at $\cos \varphi = 0.6$ once, the gold plating on the contacts will have been burnt through. It can then only be operated at this power rating or higher power rating.

Contact gap < 3 mm (μ).

Safety class II to VDE 0106-1.

7.1 DL..K

Line entrance: M16 × 1.5,
cable diameter: 4.5 to 10 mm.

Enclosure to IEC 60529: IP 54.

Diaphragm: tempered LSR diaphragm system.

Max. inlet pressure p_U or differential pressure: 5 kPa.

Permitted ambient temperature in operation:

DL..K: -15 to +85°C (+5 to +185°F),

DL..KT: -40 to +60°C (-40 to +140°F).

Storage and transport temperature:

-40 to +85°C (-40 to +185°F).

Weight: 125 g (4.4 oz).

7.1.1 Dimensions

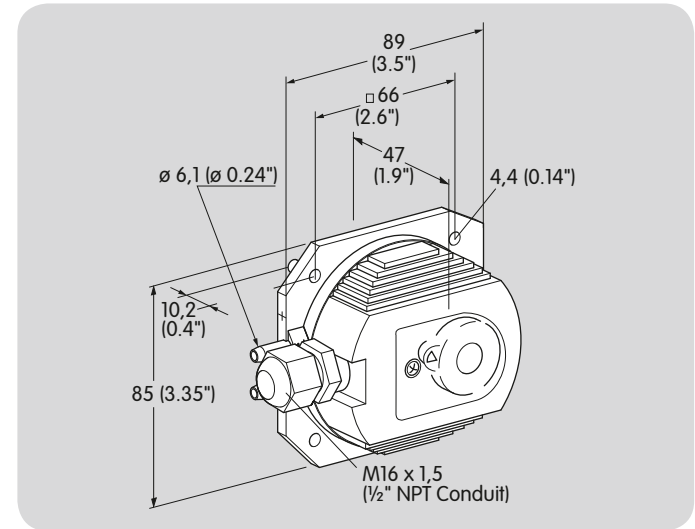

7.1.2 Adjusting range, switching differential

Type	Adjusting range				Mean switching differential at min. and max. setting				Deviation from the switching point during testing pursuant to EN 1854 or by agreement	
	Pa		"WC		Pa		"WC			
	min.	max.	min.	max.	min.	max.	min.	max.		
DL 3,3K	20	330			8	20			± 7 Pa/± 15%	
DL 3,5K, DL 3,5KT	30	350	0.12	1.4	10	20	0.04	0.08	± 5 Pa/± 15%	± 0.02 "WC/± 15%
DL 4,5K, DL 3,5KT	30	500	0.12	2	12	25	0.05	0.10	± 5 Pa/± 15%	± 0.02 "WC/± 15%
DL 5,1 K	100	510			15	30			± 15%	
DL 8K, DL 8KT	50	800	0.20	3.2	17	30	0.07	0.12	± 14 Pa/± 15%	± 0.06 "WC/± 15%
DL 11K, DL 11KT	100	1100	0.4	4.4	20	35	0.08	0.14	± 20 Pa/± 15%	± 0.08 "WC/± 15%
DL 16K, DL 16KT	400	1600	1.6	6.4	30	40	0.12	0.16	± 15%	± 15%
DL 24K, DL 24KT	200	2400	0.8	9.6	45	55	0.18	0.22	± 40 Pa/± 15%	± 0.16 "WC/± 15%
DL 40K, DL 40KT	500	4000	2.0	16.0	70	90	0.28	0.36	± 15%	± 15%

7.2 DL..A, DL..K

Diaphragm pressure switch, silicone-free.

Line entrance: M16 x 1,5,
cable diameter: 4.5 to 10 mm.

Enclosure to IEC 60529: IP 54, IP 65.

Diaphragm: NBR.

Max. inlet pressure p_U or differential pressure: see table.

Permitted ambient temperature in operation:

-15 to +80°C (+5 to +176°F),

DL..T: -40 to +60°C (-40 to +140°F).

Storage and transport temperature:

-40 to +80°C (-40 to +176°F),

DL..T: -40 to +60°C (-40 to +140°F).

Weight:

DL..A: 190 g (6.7 oz), DL..K: 220 g (7.8 oz).

7.2.1 Dimensions

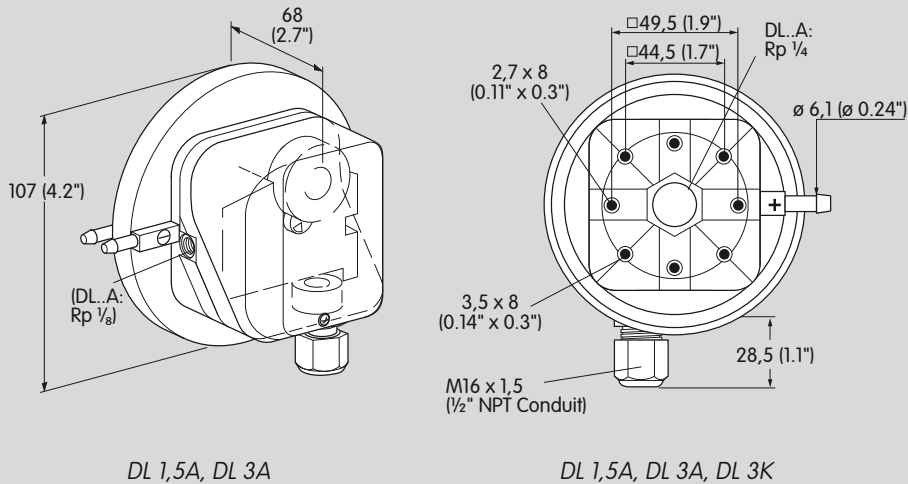

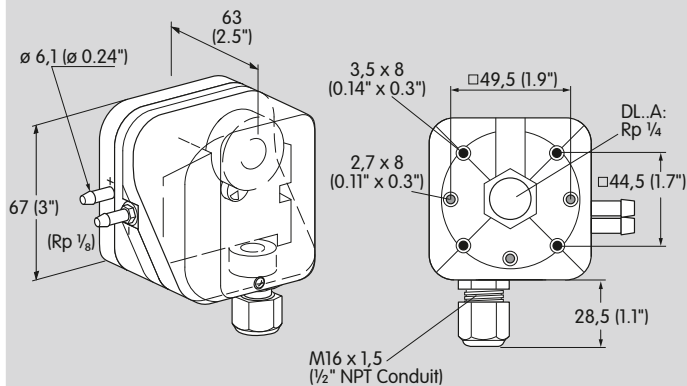

DL 5A–150A

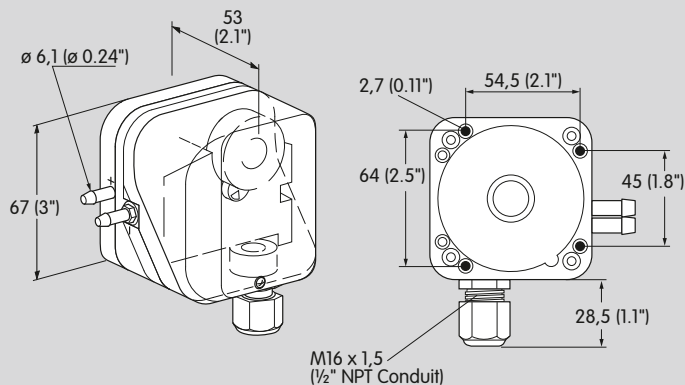

DL 5K–150K

7.2.2 Adjusting range, switching differential

Type	Adjusting range (adjusting tolerance $\pm 15\%$ of the scale value, but min. ± 8 Pa)				Max. inlet pressure		Mean switching differential at min. and max. setting				Deviation from the switching point during testing pursuant to EN 1854 Air pressure switches
	mbar		"WC		mbar	"WC	mbar		"WC		
	min.	max.	min.	max.			min.	max.	min.	max.	
DL 1,5A	-0.5	1.5			50		0.1	0.16			$\pm 15\%$ or ± 5 Pa
DL 3A, DL 3K, DL 3KT	0.2	3	0.08	1.2	50	20	0.1	0.16	0.04	0.06	$\pm 15\%$ or ± 6 Pa [± 0.02 "WC]
DL 3AT	0.3	3	0.12	1.2	50	20	0.1	0.16	0.04	0.06	$\pm 15\%$ or ± 6 Pa [± 0.02 "WC]
DL 5A, DL 5K	0.4	5			300		0.2	0.3			$\pm 15\%$
DL 5AT, DL 5KT	0.5	5	0.2	2	300	117	0.2	0.3	0.08	0.12	$\pm 15\%$
DL 10A, DL 10KT, DL 10A, DL 10KT	1	10	0.4	4	300	117	0.25	0.4	0.1	0.16	$\pm 15\%$
DL 30A, DL 30K	2.5	30			300		0.35	0.9			$\pm 15\%$
DL 50A, DL 50K, DL 50AT, DL 50KT	2.5	50	1	20	300	117	0.8	1.5	0.3	0.6	$\pm 15\%$
DL 150A, DL 150K	30	150			300		3	5			$\pm 15\%$

7.3 DL 1E–DL 50E

Enclosure to IEC 60529:

IP 10 = any installation position,

IP 21 = electrical connection from below,

IP 42/44 = with cable grommet, see page 22 (Accessories).

Diaphragm: NBR.

Max. inlet pressure p_U or differential pressure: see table.

Permitted ambient temperature in operation:

-15 to +80°C (+5 to +176°F),

DL..T: -40 to +60°C (-40 to +140°F).

Storage and transport temperature:

-40 to +80°C (-40 to +176°F),

DL..T: -40 to +60°C (-40 to +140°F).

Weight:

DL 1E, DL 3E: 145 g (5.1 oz), DL 5E–50E: 115 g (4 oz).

7.3.1 Dimensions

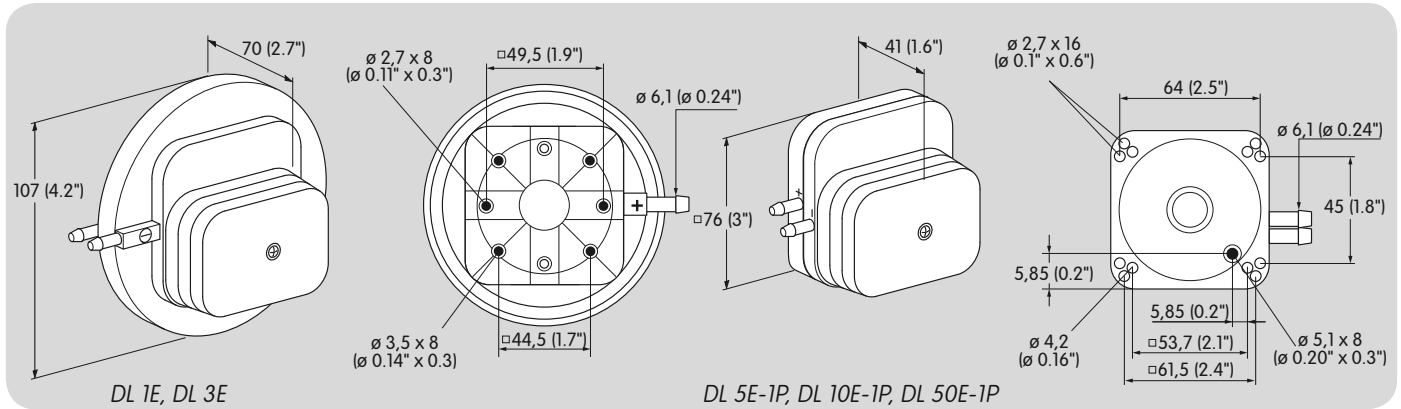

7.3.2 Adjusting range, switching differential

Type	Adjusting range (adjusting tolerance $\pm 15\%$ of the scale value)				Max. inlet pressure		Mean switching differential at min. and max. setting or by agreement				Deviation from the switching point during testing pursuant to EN 1854 Air pressure switches
	mbar		"WC		mbar	"WC	mbar		"WC		
	min.	max.	min.	max.			min.	max.	min.	max.	
DL 1E, DL 1ET	0.2	1	0.08	0.4	50	20	0.1	0.15	0.04	0.06	$\pm 15\%$ or ± 5 Pa [± 0.02 "WC]
DL 3E, DL 3ET	0.3	3	0.12	1.2	50	20	0.2	0.3	0.08	0.12	$\pm 15\%$ or ± 6 Pa [± 0.02 "WC]
DL 5E	0.4	5			300		0.25	0.4			$\pm 15\%$
DL 5ET	0.5	5	0.2	2	300	117	0.25	0.4	0.01	0.16	$\pm 15\%$
DL 10E, DL 10ET	1	10	0.4	4	300	117	0.3	0.4	0.12	0.16	$\pm 15\%$
DL 50E, DL 50ET	2.5	50	1	20	300	117	0.5	1.3	0.2	0.5	$\pm 15\%$

7.4 DL 2E–DL 35E

Enclosure to IEC 60529:

IP 00 = without cover,

IP 10 = any installation position with cover,

IP 21 = opening in cover points downwards,

IP 42/44 = cover with cable grommet.

Diaphragm: tempered LSR diaphragm system.

Max. inlet pressure p_U or differential pressure: see table.

Permitted ambient temperature in operation:

DL..E: -15 to +80°C (+5 to +176°F),

DL..EH: -40 to +110°C (-40 to +230°F),

DL..T: -40 to +60°C (-40 to +140°F).

Storage and transport temperature:

DL..E: -40 to +80°C (-40 to +176°F),

DL..EH: -40 to +110°C (-40 to +230°F),

DL..T: -40 to +60°C (-40 to +140°F).

Weight: 83 g (2.9 oz).

7.4.1 Dimensions

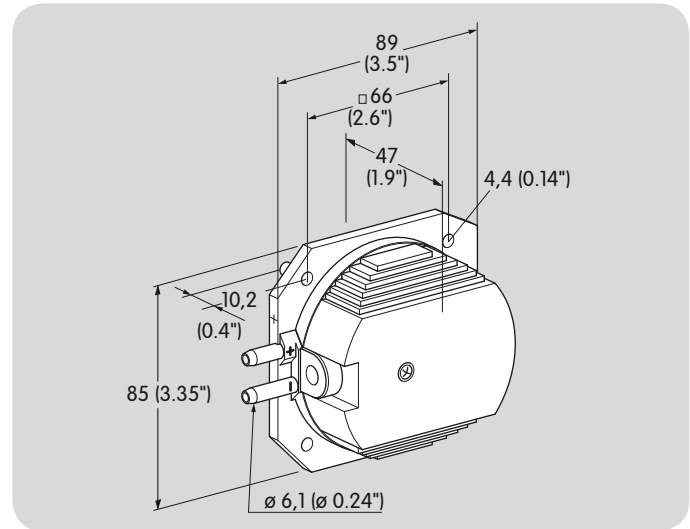

7.4.2 Adjusting range, switching differential

Type	Adjusting range (adjusting tolerance $\pm 15\%$ of the scale value, but min. ± 10 Pa [± 0.04 "WC])				Max. inlet pressure		Mean switching differential at min. and max. setting or by agreement				Deviation from the switching point during testing pursuant to EN 1854 Air pressure switches
	Pa		"WC		Pa	psig	Pa		"WC		
	min.	max.	min.	max.			min.	max.	min.	max.	
DL 2E, DL 2ET	20	200	0.12	0.8	5000	0.7	15	25	0.05	0.10	$\pm 15\%$ /min. ± 6 Pa [± 0.02 "WC]
DL 2EH	45	200			1500		15	25			$\pm 15\%$ /min. ± 8 Pa
DL 4E, DL 4ET	50	400	0.2	1.6	5000	0.7	20	50	0.08	0.20	$\pm 15\%$ /min. ± 8 Pa [± 0.03 "WC]
DL 4EH	70	400			1500		20	50			$\pm 15\%$ /min. ± 12 Pa
DL 14E, DL 14ET	300	1400	1.20	5.6	5000	0.7	30	60	0.12	0.24	$\pm 15\%$ /min. ± 40 Pa [± 0.16 "WC]
DL 35E, DL 35ET	1200	3500	4.8	14.1	5000	0.7	60	100	0.24	0.40	$\pm 15\%$ /min. ± 90 Pa [± 0.36 "WC]

8 Maintenance cycles

We recommend a function check once a year.

Feedback

Finally, we are offering you the opportunity to assess this "Technical Information (TI)" and to give us your opinion, so that we can improve our documents further and suit them to your needs.

Clarity

- Found information quickly
- Searched for a long time
- Didn't find information
- What is missing?
- No answer

Comprehension

- Coherent
- Too complicated
- No answer

Scope

- Too little
- Sufficient
- Too wide
- No answer



Use

- To get to know the product
- To choose a product
- Planning
- To look for information

Navigation

- I can find my way around
- I got "lost"
- No answer

My scope of functions

- Technical department
- Sales
- No answer

Remarks

(Adobe Reader 7 or higher required)
www.adobe.com



Contact

Elster GmbH
Postfach 2809 · 49018 Osnabrück
Strothweg 1 · 49504 Lotte (Büren)
Germany
T +49 541 1214-0
F +49 541 1214-370
info@kromschroeder.com
www.kromschroeder.com

The current addresses of our international agents are available on the Internet:
www.kromschroeder.de/index.php?id=718&L=1

We reserve the right to make technical modifications in the interests of progress.
Copyright © 2013 Elster GmbH
All rights reserved.