

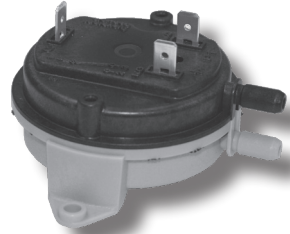

SERIES NS2™ FIELD ADJUSTABLE AIR PRESSURE SENSING SWITCH KITS

CARTON CONTENTS

- (1) NS2-0000-xx switch (see Table 1)
- (1) Set point adjustment screw (P/N 61506)
- (1) Hexagon wrench, $\frac{7}{32}$ " (P/N 60788)
- (5) Color-coded range springs (1 each, see Table 2)
- (8) Color-coded flow-restricting orifices (2 each, see Table 3)
- (1) Half strap mounting bracket (P/N 61517)
- (1) Angle bracket (P/N 61516)
- (1) Bracket attachment screw, phillips, 6-20 x $\frac{3}{8}$ " (P/N 61531-037)
- (2) Switch mounting screws, slotted hex, #6- $\frac{3}{8}$ " (P/N 27577-037)



A. ASSEMBLY

Unpack the carton and identify the **NS2™** switch and accessories using the list at the top of this page. The **NS2™ Air Pressure Sensing Switch** has a glass-filled polycarbonate housing containing a sensing diaphragm and an integral snap-acting switch with three male 90° quick-connect spade terminals. It can sense positive, negative or differential air pressure. The field adjustable set point range of this switch is **0.10" w.c. to 10.0" w.c.** Using the switch accessories contained in this kit, the **NS2™** switch can be applied to a wide variety of residential and light commercial HVAC applications.

Calibration requires a multi meter or continuity meter, a manometer, a set of test leads; plus an air source with flexible tubing and a $\frac{1}{4}$ " tee connector (see Figure 1). If you choose to seal the set point after calibration, you will also need **hot melt glue and a glue gun.** Be sure to have all of these items on hand before beginning to calibrate and install the **NS2™** switch. The switch **must** be calibrated before being placed in service. To calibrate it, you will select and install a **range spring**, and use the hex wrench in the kit to insert and tighten the **set point adjustment screw**. Note that before this is done, the switch contacts are closed in the NO position. Proceed as follows.

1. **Insert the Range Spring.** From **Table 2**, identify by color the range spring that includes the desired set point. Drop this spring into the center well on the light gray slide ("mounting pan") of the **NS2™** switch (see **Figure 2**).
2. **Insert the Set Point Adjustment Screw.** Place the black set point adjustment screw (from the kit) on the end of the hex wrench and insert it into the well over the spring. Rotate the screw slowly clockwise, just until the threads engage (see **Figure 3**). This completes the assembly of the **NS2™** switch.

B. TESTING THE CIRCUIT

1. **Connect the switch to the multi meter** to perform a continuity test of the snap switch electrical circuit before an air source is connected to the switch.
2. The snap switch contacts are in the NO position after installing the spring and adjustment screw. Connect the COM, NC and NO terminals on the switch to the corresponding connection points on the multi-meter. The NO connection will indicate as closed, showing the snap switch is in the NO condition.
3. With the air switch held in a vertical position, use the $\frac{7}{32}$ " hex wrench to rotate the calibration screw clockwise **until the NC connection indicates as closed.** If the multi meter indicates that the NO and NC connections have functioned as above, then the snap switch is functioning properly.

C. CONNECTING TO THE AIR SOURCE

1. **Connect the switch to the manometer and air source.** Using flexible tubing and a "tee", connect the air source to one of the process connections (High or Low) on the **NS2™** switch and to the corresponding (High or Low) inlet on the manometer. Keep the tubing as short as possible overall. Be sure that the length to the air switch and the length to the manometer are the same after the tee. Avoid kinks in the tubing, and keep bending to a minimum. See **Figure 1**.
2. **Apply air flow to the switch.** With power and air flow applied, the switch is ready for set point adjustment. Note that for precise calibration, the set point should be adjusted at **actual operating temperature.**



TABLE 1: MODEL SELECTION

NS2-0000-00	Basic model
NS2-0000-01	Bleed hole in Mounting Pan

TABLE 2: SPRING SELECTION

Part No.	Color	Set Point Range ("wc)
61523	Black	0.10 thru 0.30
61513	Natural	0.31 thru 0.90
61514	Yellow	0.91 thru 2.50
61515	Red	2.51 thru 5.00
61524	Blue	5.01 thru 10.00

TABLE 3: ORIFICE SELECTION

Part No.	Color	Diameter
61518001	Green	0.010
61518002	Gray	0.016
61518003	Red	0.028
61518004	Blue	0.035

D. ADJUSTING THE SET POINT

1. After completing the circuit test, and before air pressure is applied to the diaphragm, the switch contacts are in the NC position as described in Paragraph B-3 above, and shown in **Figure 4**.
2. Adjust the air flow until the desired set point appears on the manometer's display. This will cause the contacts to change to the NO position.
3. Using the $\frac{7}{32}$ " hex wrench, turn the NS2™'s adjusting screw clockwise, in small increments, until the contacts change state to NC, as indicated on the multi meter.
4. To verify the air switch set point, increase the air flow so that the switch contacts change to the NO position, and note the reading on the manometer. Then decrease the air flow until the contacts change to the NC position, and note the reading on the manometer. Confirm that, at the specified set point, the NC or the NO indicator on the multi meter comes on. Repeat this adjustment process as needed until satisfactory set point is achieved.
5. Seal the adjusting screw using hot melt glue following precise calibration, if desired.

E. MOUNTING (FIGURES 5 & 6)

1. Select a mounting location free from vibration. Mount with the diaphragm in any **vertical plane**. Do not mount with the sample line connections directed upward.

2. Refer to **Figure 6** for the mounting dimensions of the integral foot bracket. Using the two **#6- $\frac{7}{16}$ " slotted hex mounting screws**, mount the calibrated **NS2™** switch via the **integral foot bracket**.
3. Optionally, mount the calibrated **NS2™** switch via one of the two metal brackets included in the kit. See **Figure 5** to identify the **angle bracket** and the **half strap bracket**. If using one of these brackets, first attach it to the **NS2™** switch with the 6-20 x $\frac{3}{4}$ " self-tapping phillips screw provided. Then follow step 1 above to mount the switch, placing the two **#6- $\frac{7}{16}$ " slotted hex mounting screws** through the preferred set of mounting holes on the bracket.

F. ELECTRICAL CONNECTIONS

1. The snap switch has three $\frac{1}{4}$ " x .032" 90° male quick connect spade terminals. Connect them to the corresponding application wire terminals and apply power.

G. AIR SAMPLING CONNECTION

1. The integral sample line connectors are located on either side of the diaphragm. As marked on the switch, the High or Positive inlet (**P1**) is black and the Low or Negative inlet (**P2**) is gray.
2. Connect the sample lines to the application using flexible tubing as follows:
 - **Positive Pressure Only:** Connect the sample line to **P1**; **P2** remains open to the atmosphere.
 - **Negative Pressure Only:** Connect the sample line to **P2**; **P1** remains open to the atmosphere.
 - **Two Negative Samples:** Connect higher negative sample to **P2**; lower sample to **P1**.
 - **Two Positive Samples:** Connect higher positive sample to **P1**; lower sample to **P2**.
 - **One Positive and One Negative:** Connect positive sample to **P1**; connect negative sample to **P2**.

H. USING A FLOW-RESTRICTING ORIFICE

1. Some applications require a **delayed** switching action after set point is reached. The delay is created by inserting an orifice plug into either or both of the sample line connectors to restrict the air flow. Eight (8) orifice plugs in four color-coded sizes are included in the kit as shown in **Table 3**.
2. More information about orifice plugs is available in **Technical Bulletin TB101504-2-NS2, Effects of Air Flow Restriction on NS2™ Air Switch Operation**.

I. BLEED HOLE (OPTION)

1. A bleed hole, located on the negative sample line connector, can be provided to reduce the build up of condensation in the NS2™ switch and sample line (see Table 1).
2. If a bleed hole is present, the switch **must** be mounted with the diaphragm in the vertical position and the sample line connectors directed downward. Mount the switch above the sample point to prevent condensation from migrating into the pressure switch.

FIGURE 1: SET-UP FOR CALIBRATION OF THE NS2™ SWITCH

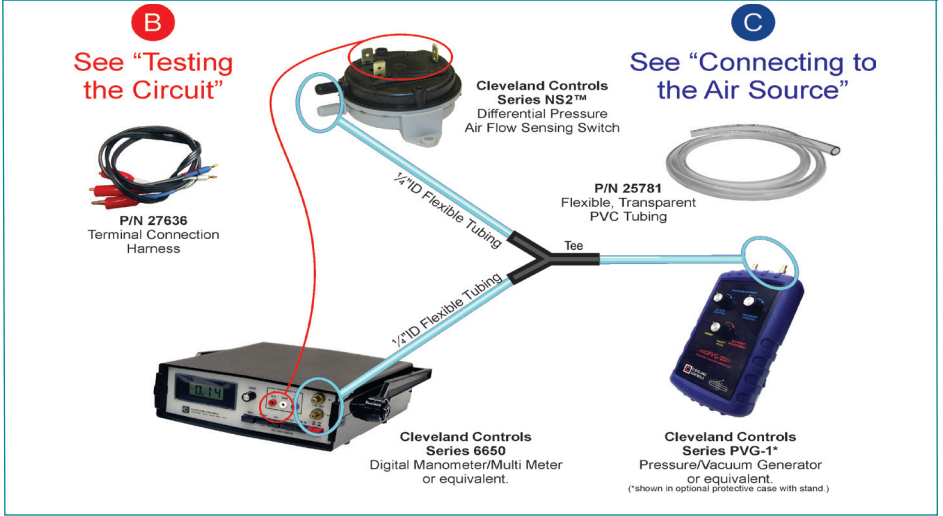

FIGURE 2: INSERT A RANGE SPRING

(Assembly Step 1): The kit contains five (5) color-coded range springs (see Table 2). Select the correct one for the desired set point and insert it into the well on the NS2™ switch.

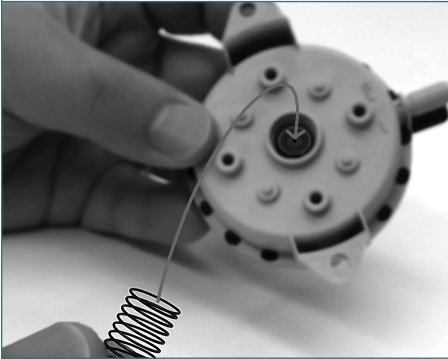

FIGURE 3: INSERT THE SET POINT ADJUSTMENT SCREW

(Assembly Step 2): With the range spring in place, insert the set point adjustment screw into the well on the NS2™ switch. Use the hex wrench provided to rotate it until the threads engage.

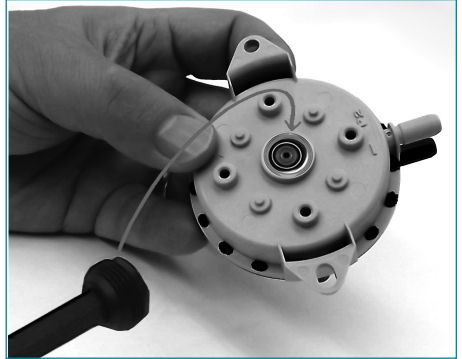
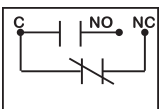
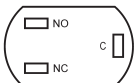

FIGURE 4: ELECTRICAL CONNECTIONS



SPDT



After the circuit continuity test has been completed, the switch contacts are in the disengaged (NC) position as shown before air pressure is applied to the diaphragm.

FIGURE 5: OPTIONAL MOUNTING BRACKETS

These metal brackets offer a variety of mounting holes and slots. Use the **6-20 x 3/8" self-tapping philips screw** to attach a bracket to the NS2™. Then, to mount the switch, insert the **two #6-3/8" slotted hex mounting screws** through the preferred set of mounting holes on the bracket.



Half Strap Bracket
(P/N 61517)

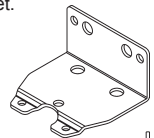

"L" Bracket (P/N 61516)

GENERAL SPECIFICATIONS

Body Material: Glass-filled polycarbonate.

Diaphragm Material: Silicone.

Operating Range: 0.10" wc to 10.0" wc.

Maximum Pressure Rating: 14" wc.

Mounting (standard): Diaphragm vertical. For mounting at custom angle, consult factory. *

Operating Temperature: -40 to 88 °C. (-40 to 190 °F).

Sample Line Connectors: Straight type, accepts flexible tubing.

Sample Line Connections:

Black=positive Gray=negative.

Sample Medium: Air and byproducts of combustion that will not degrade silicone or polycarbonate.

Electrical Connectors: ¼" x .032" 90° quick-connect spade terminals.

Standard Contacts: Fine silver.

Contact Arrangement: SPDT.

Position of Contacts: with spring engaged and before pressure is applied, NC.

Switching Action: change contact position at set point.

Electrical Rating:

• **SPDT Electrical load:**

½ HP @ 120 to 277 Vac.

28 VA pilot duty @ 24 Vac.

125 VA pilot duty @ 120 Vac.

• **SPST Electrical load:**

5 Amps resistive @ 24, 120 to 277 Vac.

*To meet published specifications, the NS2™ switch must be calibrated and installed with the diaphragm in a vertical plane. For assistance in installing this switch with the diaphragm in a different position, and the effects of doing so, please consult the factory.



CARBON MONOXIDE (CO) GAS EXPOSURE CAN CAUSE BRAIN DAMAGE OR DEATH

This pressure switch may control air flow into the combustion chamber. Improper adjustment of the pressure switch in the field, or use of the switch for an application for which it was not intended, may introduce carbon monoxide into the ventilation system or combustion chamber.

The U.S. Consumer Product Safety Commission warns that carbon monoxide gas is an "invisible killer." Carbon monoxide (CO) is a colorless, odorless, deadly gas produced by burning fuel, including natural gas and propane. Symptoms of carbon monoxide exposure include dizziness, headache, nausea, weakness, sleepiness, muscle twitching, vomiting and inability to think clearly. If you experience these symptoms, turn the HVAC system off, exit the building, and get into fresh air immediately. The pressure switch must be tested thoroughly by an HVAC professional before the HVAC system is restarted. Proper installation, operation and maintenance of fuel-burning appliances and HVAC systems is the most important factor in reducing carbon monoxide poisoning. For safe operation, be sure all such devices are installed by professionals and operated according to manufacturer's instructions and applicable local codes. Have HVAC systems (including pressure switches) inspected and serviced annually by a trained service technician. Examine vents regularly for improper connections, visible cracks, rust or stains, and blockage.

Install battery-operated carbon monoxide alarms certified to the requirements of the most recent UL, IAS and CSA standard for carbon monoxide alarms. Test the alarms regularly and replace the batteries annually.

If you have any questions regarding the installation, use or safety of this switch, please call Cleveland Controls Customer Service at (216) 398-0330.

FIGURE 6: DIMENSIONS OF NS2 SWITCH WITH INTEGRAL CONNECTORS AND MOUNTING FEET. THE STANDARD CONNECTORS ACCEPT FLEXIBLE TUBING.

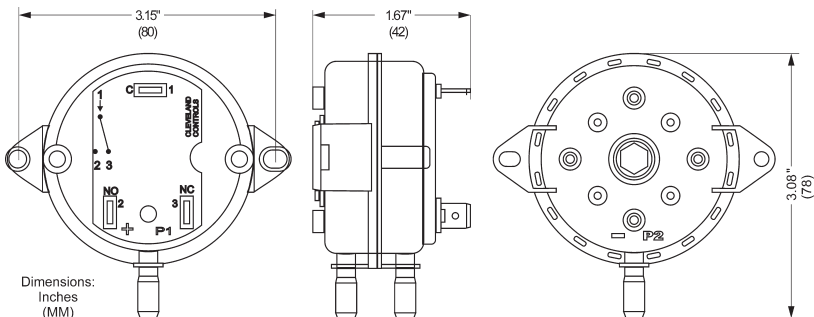

Are you reading a FAX or a COPY of this bulletin? DOWNLOAD the full-color PDF version of this and other literature at our website: <http://www.clevelandcontrols.com>